

Office Bearers of MEA 2020-2021

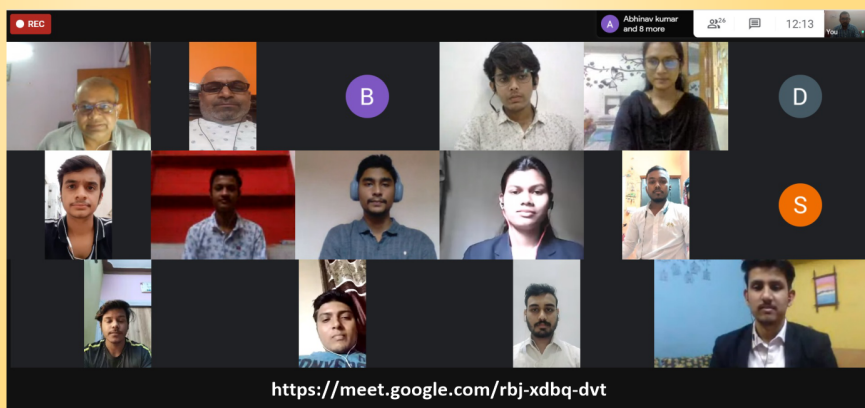

TEAM MEA	
DESIGNATION	NAME
TREASURER	YASHRAJ LALWANI
SPONSOR ANALYST	HUSAIN GONDIAWALA
LITERARY INCHARGE	ARPIT SHRIVASTAVA SAURABH SINGH
DISCIPLINE INCHARGE	ANUJ KU. SINGH SHUBHAM SHARMA
LOGISTICS	UMESH VERMA (HOSTEL) MANISH SAHU (CITY)
AUDIO/VISUAL INCHARGE	SEEMANT SONI E. SHARATH KUMAR
RECEPTION INCHARGE	SHIVANGI SAHU DIWAKAR SAHU
PUBLICITY INCHARGE	SHOURYA BARVE BHAVYA BESRE
CULTURAL INCHARGE	DEVENDRA TONDON NIDHI SAHU PULKIT NAYAK

Oath Taking Ceremony



Editorial Board

Editor In Chief

Piyush Pandey
Mech. 8th Semester
Managing Editor
Anuj Kumar Singh
Mech. 6th Semester

Photography

Seemant Soni
Mech. 8th Semester

Mentor

Mr. Manish RK Sahu
Assistant Professor

Mechanical Engineering Association

Instagram

 @mechanical_engg_association

Facebook

 www.facebook.com/MEASSIPMT

Website

 mea-ssipmt.wixsite.com/2008

Youtube

 tinyurl.com/YoutubeMEA

“To give real service,
you must add something
which cannot be bought
or measured with money”

SIR M. VISVESVARAYA

God of Engineering, India
Recipient of “Bharat Ratna”

ANALYSIS OF MAGLEV VERTICAL AXIS WIND TURBINE

Magnetic levitation is a method by which an object is suspended with no support other than magnetic fields. Magnetic pressure is used to counteract the effects of the gravitational and any other accelerations. The principal advantage of a maglev windmill from a conventional one is, as the rotor is floating in the air due to levitation, mechanical friction is totally eliminated. That makes the rotation possible in very low wind speeds, which is the new direction to improve the performance of wind turbines. In this project work, magnetically levitated (maglev) wind turbines are designed and developed. It is the self-starting turbine. 3D Designing can be done using Solidworks software and Finite Element Analysis can be used to study effect of air flow on the Turbine blade using ANSYS FLUENT. The choice for this model is to showcase its efficiency in varying wind conditions as compared to the traditional horizontal axis wind turbine and contribute to its steady growing popularity for the purpose of mass utilization in the near future as a reliable source of power generation. Power will then be generated with an axial flux generator, which incorporates the use of permanent magnets and a set of coils. Inverter circuit is used to convert DC voltage to AC voltage by rectifying it. Vertical axis wind turbines offer promising solution for smaller sized residential ruler areas or medium spaces.



Mr. Manish RK Sahu
Asst. Prof.
Dept. of Mechanical Engg.
SSIPMT, Raipur

AI IN MECHANICAL ENGINEERING

Mechanical Engineering is the primary consumer of Artificial Intelligence as a technology which consumes more than any other industry. It has consumed the most in Mechanical designs or engineering works. Sections of Mechanical Engineering like Robotics, Automation, or sensor technology, uses Artificial Intelligence as a technology. So it is easy to say that Mechanical Engineering disseminates the application and use of AI in the eco-system. The idea behind the work of AI remains the same. It performs activities without humans yet with increased tendency as compared to humans. It is prioritizing the automated part of work, where we feed the computer with data, and as per the command, the machine/process continues its function.

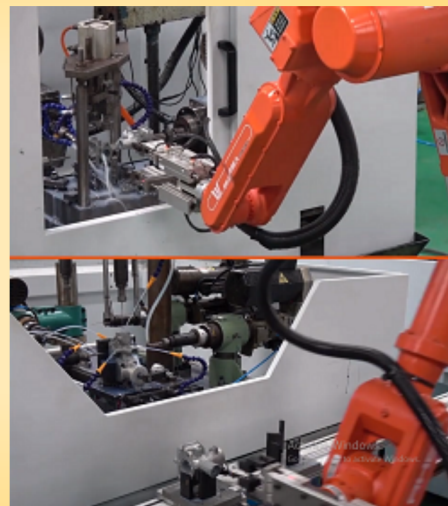

Mrs. Neha Verma
Asst. Prof.
Dept. of Mechanical Engg.
SSIPMT, Raipur

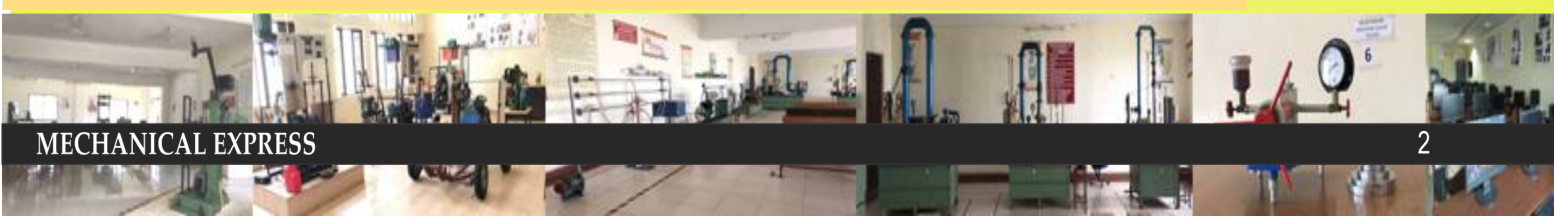

SMART MATERIALS

Smart materials can impart information about their environment to an observer or monitoring device and are revolutionizing fields as diverse as engineering, optics, and medical technology. Advances in smart materials are impacting disciplines across the scientific and technological landscape. The smart materials concept is based on integration of sensors with materials, so that the material has its own nervous system, able to sense as well as communicates with outside intelligence. This material has built-in or intrinsic sensor (s), actuator (s), and control mechanism (s) by which it is capable of sensing a stimulus, responding to it in a predetermined manner and extent, in a short or appropriate time and reverting to its original state as soon as the stimulus is removed. There are numerous kinds of smart material available such as piezoelectric materials, thermo-responsive materials (shape memory alloys or shape memory polymers), magneto restrictive materials, PH-sensitive materials, chromogenic systems, and Polymer gels etc. The prime objectives of adapting smart structures are shape control, vibration control, noise/acoustic control, flow control, precision systems, monitoring, and diagnosis etc. There is various reported application area of this modern material, such as aeronautics and space craft, satellite antenna, military aircraft, automobiles, ground transportation systems, optics, electronics, and bio-medical implants etc.



Dr. Rityuj Singh Parihar
Asst. Prof.
Dept. of Mechanical Engg.
SSIPMT, Raipur

AQUAPONICS FARMING

Abstract:- The aquaponics systems focused on increasing economically and sustainability of indoor and outdoor fish farming. Aspect like sustainability, development and economically efficiency improve of farmer health we must reconsider the agriculture sciences, by this we understand that we must develops technologies friendly for the environment. Combining aquaculture with hydroponics we obtain a new innovation named aquaponics which respects principles of sustainable agriculture (wastewater bio filtration by plants) and gives us the possibility to increase economic efficiency with an additional production (organic vegetables) to produce the nutrient rich food. Aquaponics may be regarded as the integration of two relatively well established production technologies: recirculating aquaculture systems in which fish tank effluent is treated and cleaned before being returned to the fish tank; and hydroponic (or soil-less) nutrient solution based horticulture systems. Bringing together allows for the plants to utilize the waste nutrients produced by the fish. In principle it is very similar to a freshwater aquarium in which both plants and fish are grown.

Strengths of aquaponics :-

1. Efficiency of water use.
2. Independence from soil.
3. High levels of nutrient utilization.
4. Hydroponic systems also capture a high proportion of nutrients.



Anuj Kumar Singh
8th Sem. Mechanical



Seemant Soni
8th Sem. Mechanical

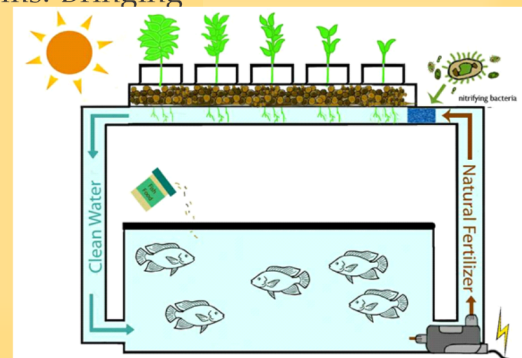

DESIGN & FABRICATION OF GO-KART

In this growing age of technology and fast moving world, everyone need some help to make their work little more convenient. Be it industrial, rural or urban places, new gadgets for convenience are always welcome. And for this what could be better than multi-utility, double seater, four wheeled go-kart that ensures passenger's safety and protection from various environmental conditions, that too in the price of a normal two-wheeler. The go-kart is designed and fabricated to bear the load of <200 Kgs and provide ease of driving and comfort to passenger various track conditions.

Remarkable features of the go-kart are:-

1. Power-output can be generated from engine that can be used to run different equipment, such as water pumps, chaff cutter, etc.
2. Four wheeler double seater vehicle with protection from climatic conditions & dust, extra boot-space and more comfortable than bike at affordable price.
3. Can be used as multi-utility farm vehicle.
4. Safety features like ignition controlled by alcohol detection, seat belt detection device.

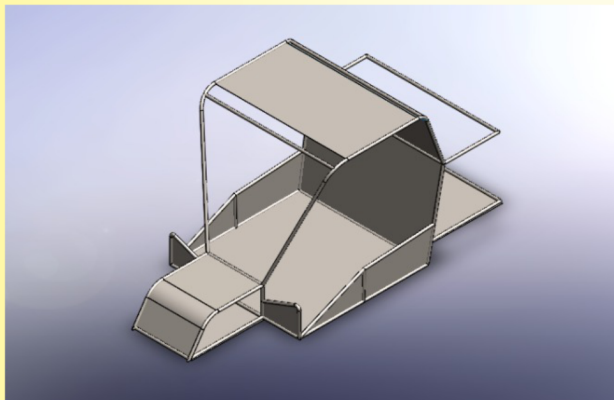

Arpit Shrivastava
8th Sem. Mechanical



Piyush Pandey
8th Sem. Mechanical



Saurabh Singh
8th Sem. Mechanical



Shivangi Sahu
8th Sem. Mechanical

EVENTS CONDUCTED BY MEA

S.No.	Date	Name of the Event
1	17/06/2020	Q-Fiesta (Online Quiz)
2	03/07/2020	Apti-King/Apti-Queen (Online Aptitude Test)
3	10/07/2020 to 22/07/2020	Naadswaram (Singing & Instrumental Competition)
4	08/07/2020	Webinar on "Unleashing Coal – The New Opportunities for Mechanical Engineers and Aspirants"
5	15/08/2020	Oath Taking Ceremony : MEA 2020-2021
6	05/09/2020	Teacher's Day Celebration
7	28/08/2020 to 10/09/2020	Preliminary Round of SGT 4.0
8	26/09/2020	SGT – Grand Finale (Live on Youtube)